

kettal

4–25

Eolias

26–35

Plumon

36–39

Grand Bitta

40–53

Pavilion H New features

54–71

A

72–79

Kall

80–95

Pavilion O New features

Eolias, by Antonio Citterio

Eolias Collection by Antonio Citterio, inspired by the breathtaking archipelago located off the coast of Sicily. This versatile collection includes a range of indoor and outdoor furniture pieces designed to elevate any space.

One of the collection's highlights is the Eolias Salinas series, which features a chair, club chair, and club lounge chair made from sturdy aluminum with a woven wicker detail. These pieces come in both indoor and outdoor versions, with the indoor chairs available with or without wheels for added convenience.









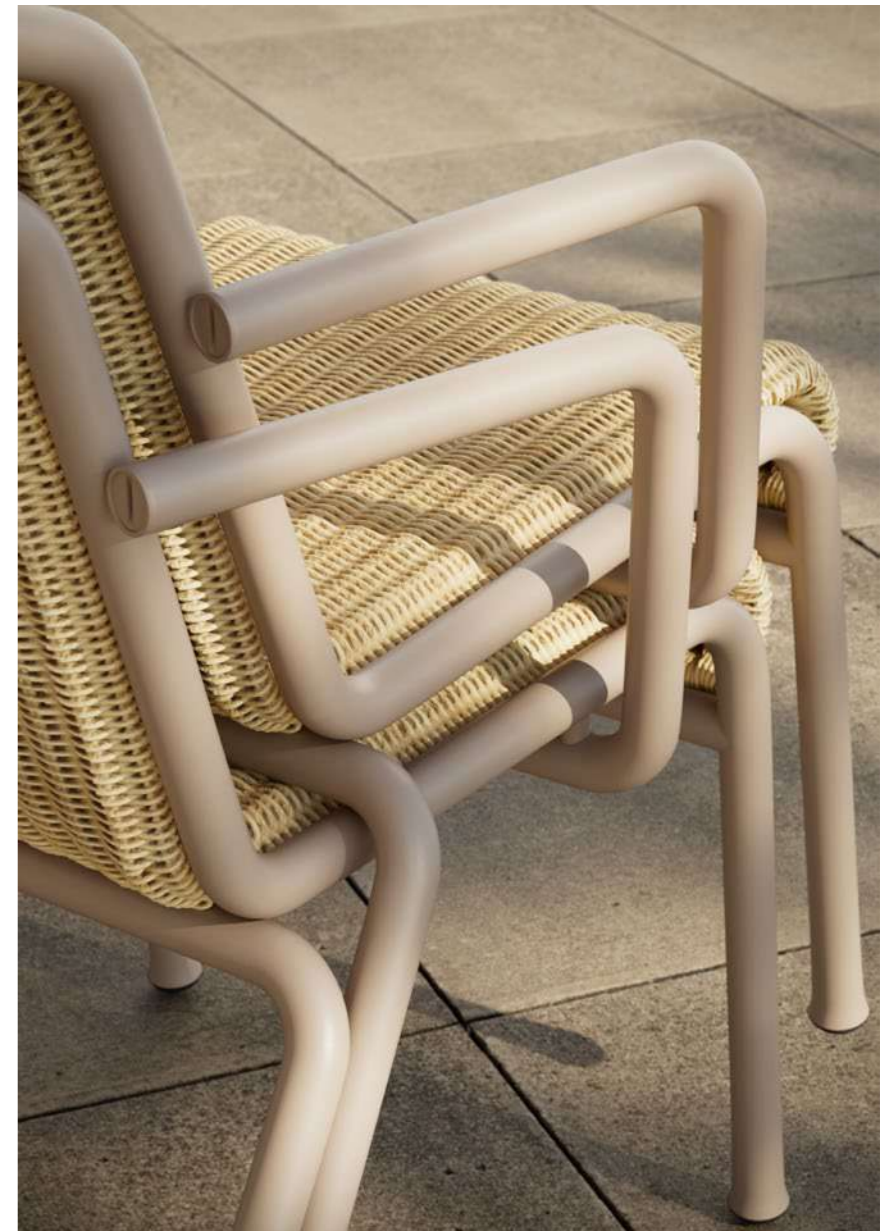







Eolias Salina
Dining Armchair

KSB200600

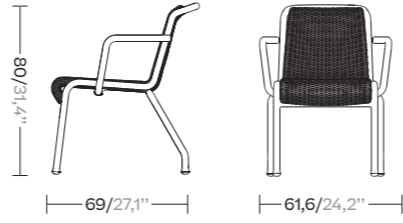

Eolias Salina
Club Armchair

KSB200800

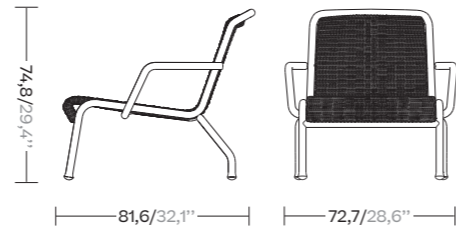

Eolias Salina
Lounge Club

KSB200900

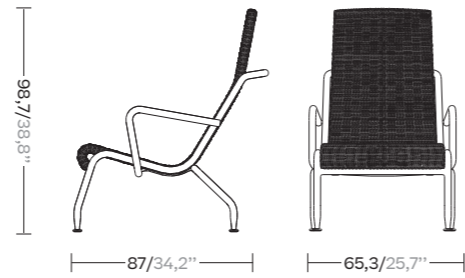

Eolias Panarea
Dining armchair

KSB200700

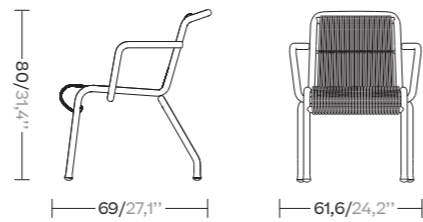

Eolias Lipari
Dining table

KSB201000 folding

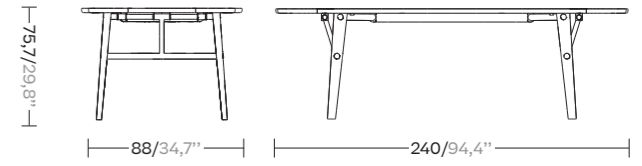

Eolias Lipari
Dining table

KSB201100 folding

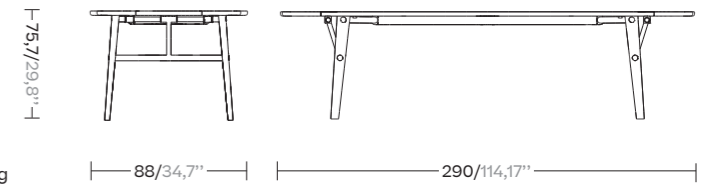



Workplace

Eolias Salinas

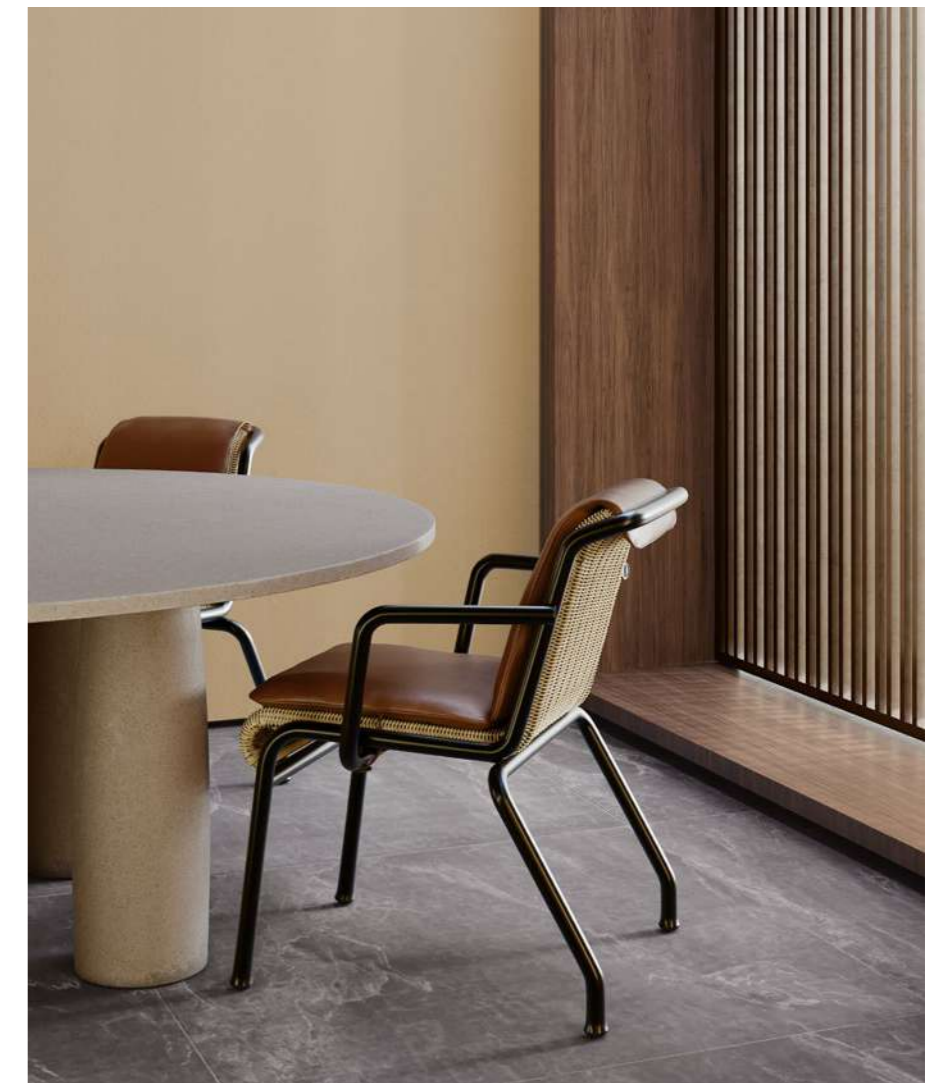



Eolias Salinas
Dining Armchair

KSB200100
KSB200200 with wheels

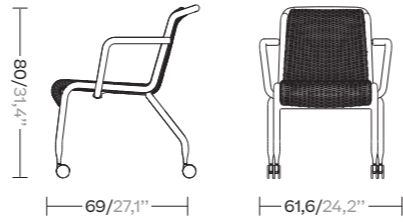

Eolias Salinas
Club Armchair

KSB200300
KSB200400 with wheels

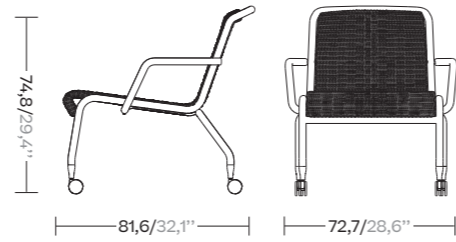



Plumon, by Patricia Urquiola

Inspired by the concept of dressing and undressing furniture, this collection features elegant and versatile pieces that add sophistication to any living space.

Our stackable teak chair with two cushion options offers both comfort and versatility, perfect for outdoor settings. The new Club armchair, a stylish and versatile chair, the perfect blend of form and function, adding sophistication to any space.

The ceramic side table with Glaze finish adds a unique touch to your living space, available in a range of colors

to suit any style. Meanwhile, the central ceramic table is a true statement piece, also available in Glaze colors, with a striking design and eye-catching finish.

Each piece in the Plumon collection embodies the perfect fusion of form and function, with exquisite attention to detail and premium materials. Whether you're looking to create a stylish outdoor oasis or elevate your indoor living space, the Plumon collection has something for everyone.











Dining Armchair

KS7400600/KS7401900

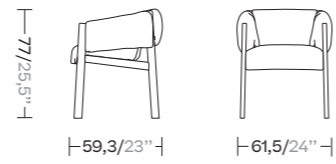

3 Seaters Sofa

KS7400500

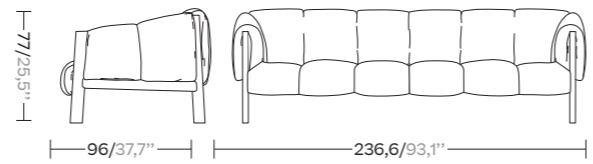

Side table

KSA800900

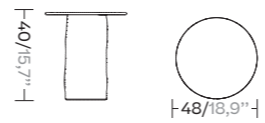

Central table

KSA801000

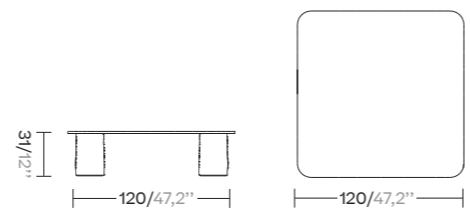



Grand Bitta, by Rodolfo Dordoni

Crafted from a blend of ropes, teak, and aluminum, this stunning piece is fully customizable with a range of rope and fabric colors to suit your style. Designed with outdoor lounging in mind, the Daybed's generous size and comfortable design make it the perfect addition to any patio or poolside. Enjoy luxurious relaxation in style with the Grand Bitta Daybed.

The Grand Bitta collection features a unique combination of aluminum and teak legs, seats made

of braided polyester, and comfortable cushions, with teak or stone table tops, all crafted from waterproof materials. The designer's intention was to create a dense braiding that would allow air to flow through, evocative of the braiding used to moor boats (hence the name "Bitta," which means "mooring" in Italian). The result is a collection of pieces that appear light and airy, while also providing cozy, natural-hued nests to unwind in.



Daybed

KS7003600

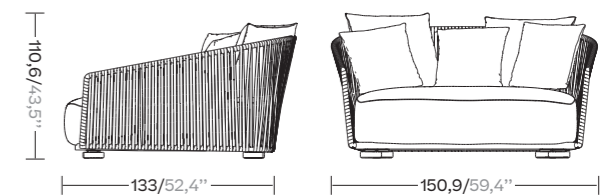



Pavilion H

Experience the ultimate in outdoor living with the Outdoor Pavilion H - the fully configurable pergola that's taking the market by storm. With a range of new components that are sure to impress, including a new bioclimatic roof with cutting-edge technology and a sleek, redesigned shape, a waterproof aluminum roof, a polycarbonate roof, new canopies with slats, stylish louvers, new aluwood carpentry, and a glazed side, this pavilion is the perfect way to create a customized outdoor oasis that's uniquely yours. But that's not all - the Outdoor H Pavilion is now smart home compatible, which means you can control everything from the lights to the fan with the Kode

app. And with the ability to configure your pavilion to your exact specifications, you can create the perfect outdoor space for relaxing, entertaining, or anything in between.

Whether you're looking to create an intimate outdoor retreat or a spacious entertainment area, the Outdoor H Pavilion has everything you need to make your vision a reality. So why wait? Upgrade your outdoor living space today with the ultimate in customizable outdoor living - the Outdoor H Pavilion.



New Bioclimatic ceiling

New bioclimatic roof system for H Pavilions that boasts a quieter operation and sleek new design. The roof features adjustable blades for optimal ventilation and light control, as well as an automatic rain sensor. The hidden motor not only enhances the overall aesthetic of the pavilion, but also reduces noise pollution for

a more tranquil outdoor living experience. This new bioclimatic roof system is a modern addition to Kettal's line of outdoor furniture, offering a minimalist look and functional benefits to users who seek a cleaner and more sophisticated outdoor living space.



A bioclimatic roof uses natural elements to regulate temperature and energy efficiency. A silent and clean design reduces noise pollution and provides a modern aesthetic appeal. An eco-conscious choice for sustainable living.

New Aluminium ceiling

The new watertight aluminum fixed roof for H pavilions in a wood-like finish is a stunning addition to any outdoor venue. Made from high-quality aluminum, this roof provides superior protection against water damage and weather elements, while its wood-like finish adds a touch of natural beauty.

The wood-like finish of the roof is achieved through a unique painting process that simulates the appearance of wood. This finish adds a warm and rustic feel to the pavilion, making it a perfect fit for outdoor events in natural settings.

Installation is quick and easy, with minimal disruption to the event schedule. The roof can be installed in a matter

of days, providing immediate protection from heavy rains and other extreme weather conditions.

In addition to its practicality and aesthetic appeal, the aluminum fixed roof is also environmentally friendly. The use of aluminum reduces the need for natural resources and the roof can be recycled at the end of its lifespan.

Overall, the new watertight aluminum fixed roof in a wood-like finish for H pavilions is an excellent investment for event venues looking to enhance the protection and beauty of their space while also prioritizing sustainability.

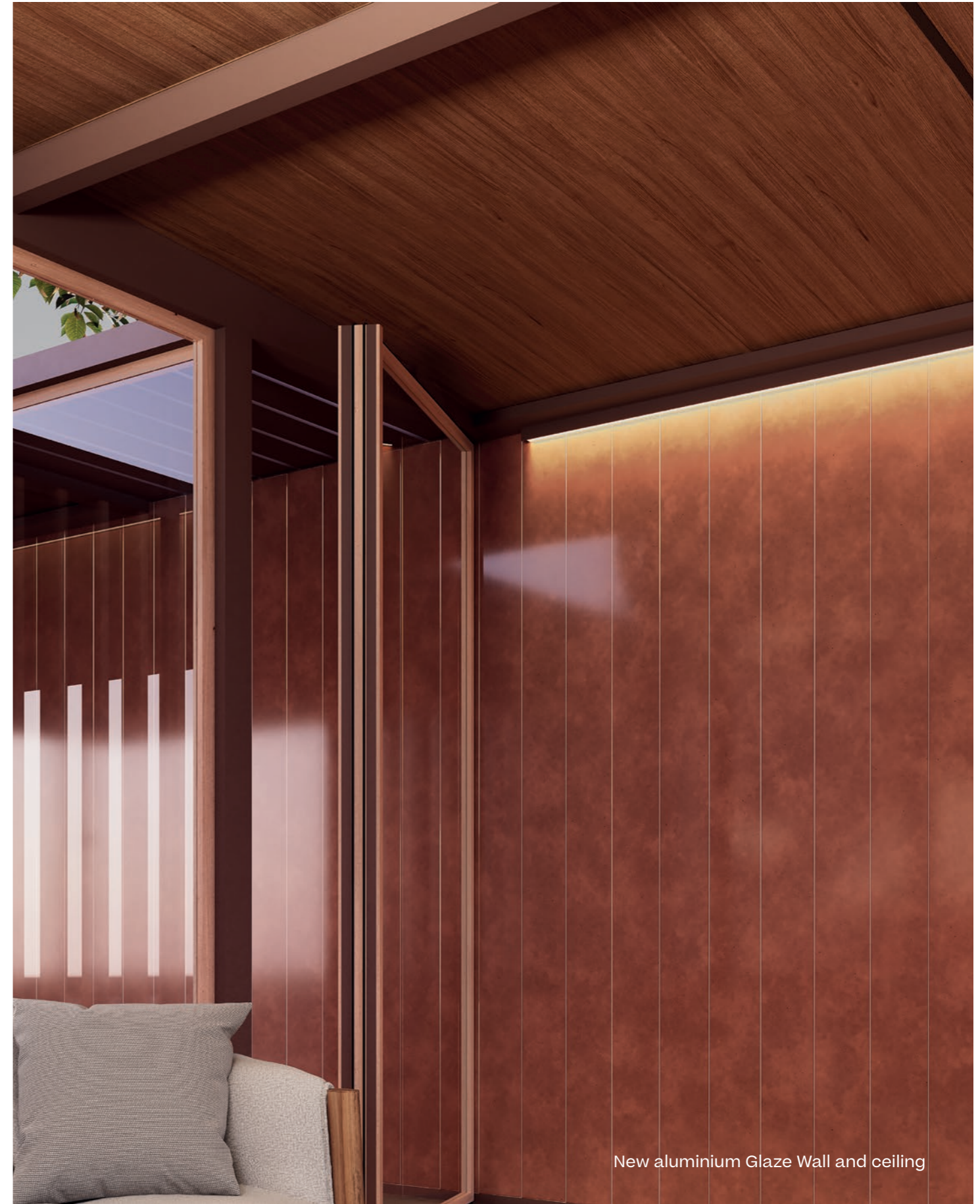

New aluminium Glaze Wall and ceiling

Polycarbonate ceiling

The Pavilion H has just been equipped with an exceptional new feature - a watertight polycarbonate roof that boasts a unique curved design to ensure effective drainage through the columns. This new addition not only serves a practical purpose, but it is also visually stunning, allowing natural light to penetrate the space below.

The transparent material used in the construction of this roof allows for a seamless integration with the surrounding environment, adding to the Pavilion H's already impressive aesthetic. Guests can now enjoy uninterrupted views of the sky above, while remaining comfortably sheltered from the elements.

The innovative design of this roof also provides an extra layer of insulation, making the Pavilion H more energy-efficient and sustainable than ever before. Whether it's a sunny summer day or a rainy winter afternoon, this new feature ensures that guests can continue to enjoy the Pavilion H's offerings no matter the weather.

In short, the Pavilion H's new watertight polycarbonate roof with a unique curved design is a game changer, allowing for maximum functionality, aesthetics, and sustainability. It is an exciting addition to the Pavilion H, sure to leave a lasting impression on all who visit.

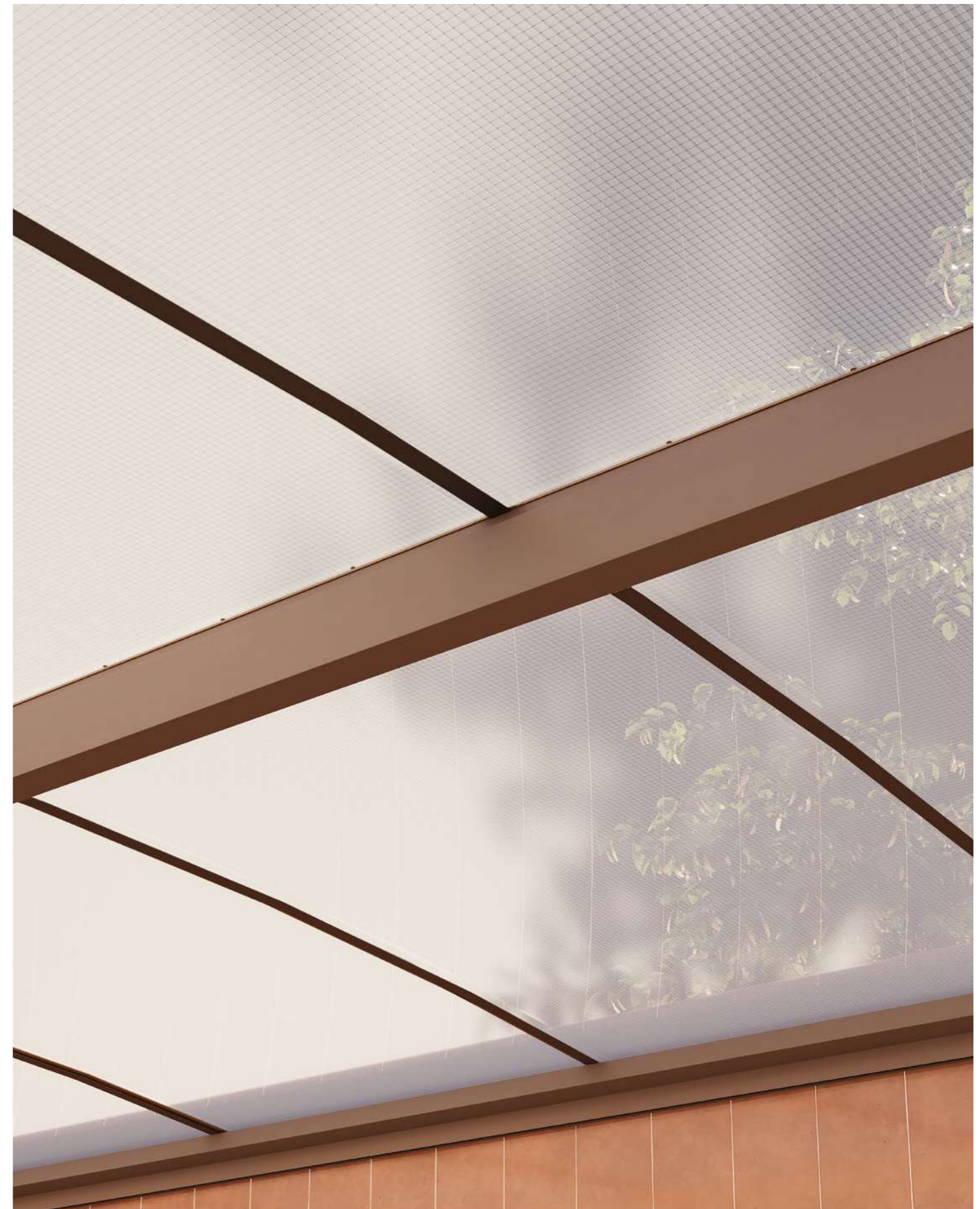

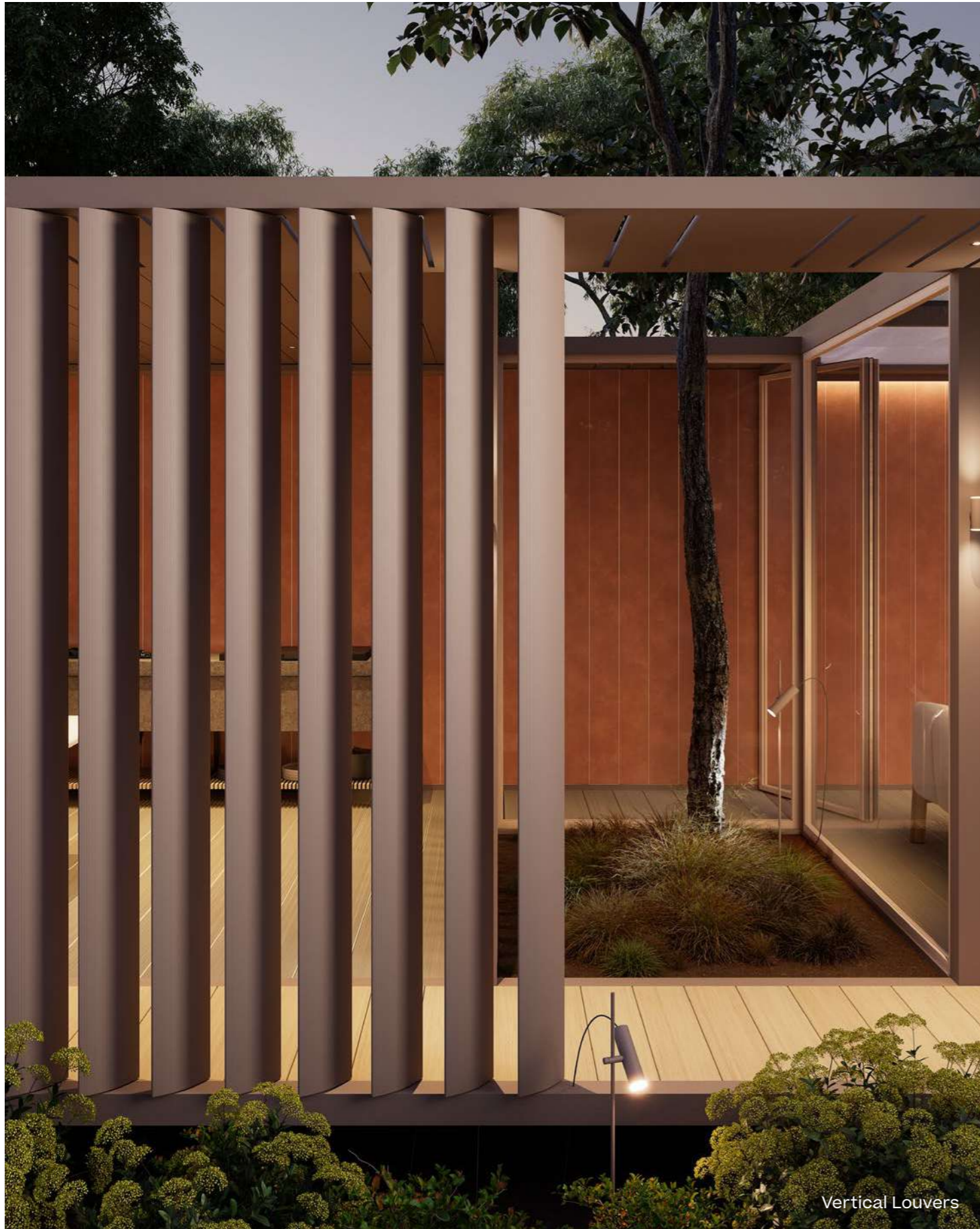

Kode

Kode turns your pavilion into a smart home that you can control from miles away or from your sofa: Adjust the ceiling opening, control the lights, temperature and ventilation, and you can even open and close the blinds. Pavilion H is now a connected smart Pavilion.

Kode app was designed with the goal of bringing mobility and intelligence into one parallel action. With it, Kettal's Pavilion H users can now control and master the various functionalities at various distances from their Pavilion H via their cell phones. Inspired by the rationalism of German industrial designer Dieter Rams, Kode is a minimalist home automation app. Its discrete concept in analogy to a remote control, is designed with slim and elegant action elements, with functionalities basic to the proper use of the Pavilion and other elements. Kode app is a new Kettal app, uniting technology, architecture and design in one.



powered by
somfy.





A, by Naoto Fukasawa

Chairs and desks made of solid wood are not very common in the office environment. The concept of working places integrating home and office made a change, and I think it became more like that. The touch of our hands and bodies with the wood means coexisting with trees and getting closer to nature. It means living together.

Wooden round bars do not cast strong line shadows in the space. It is beautiful and warm, in harmony with air, light, and people.

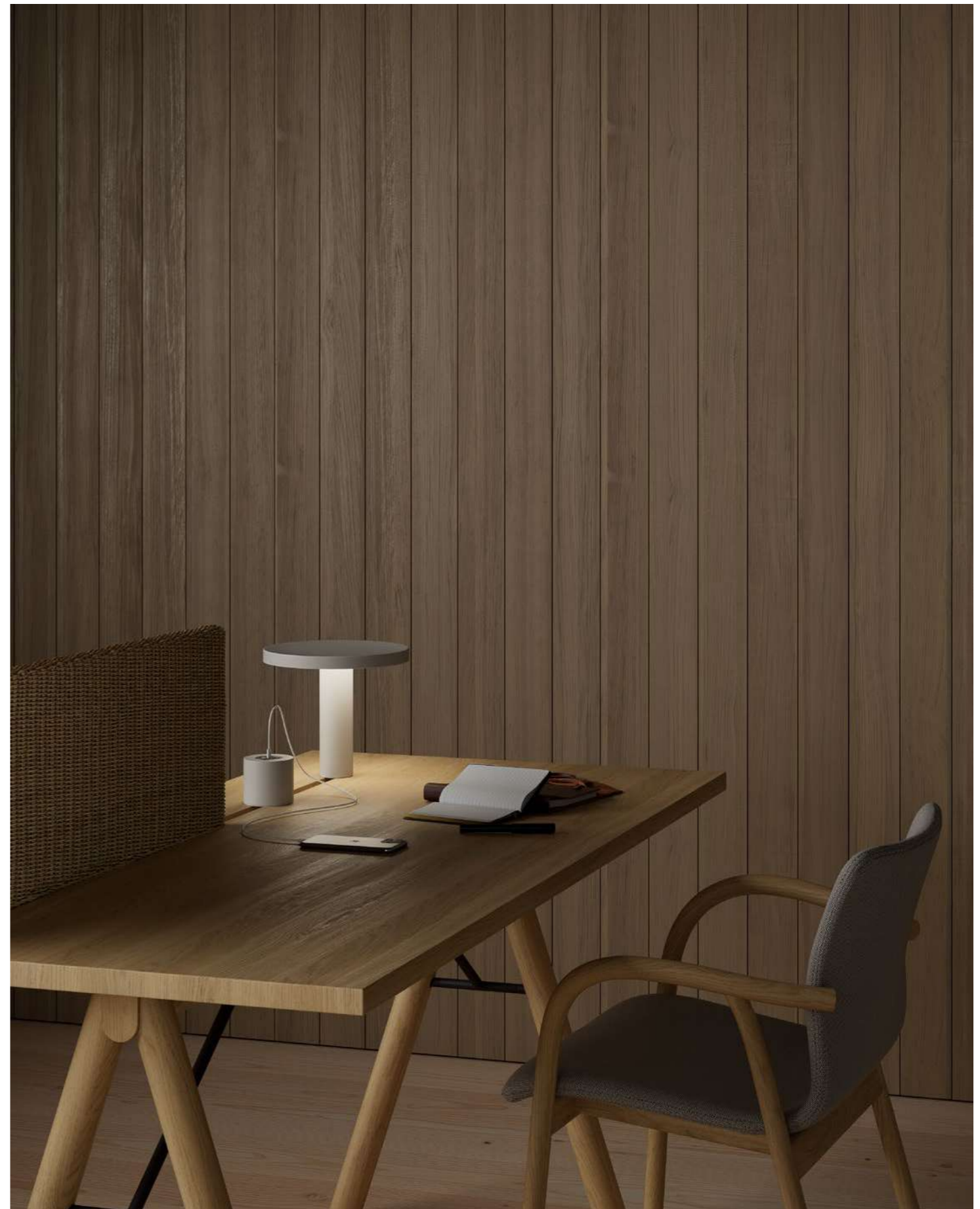





Accesorios A system

Lamp

Add a touch of style and functionality to your System A desk with our sleek ceramic lamp. This versatile lamp can be easily moved from side to side, providing customizable lighting to meet your needs. The dimmable feature allows you to adjust the brightness to your liking, while the ceramic material gives it a modern and sophisticated look. In addition, the lamp features a convenient tray for storing small desk accessories like clips and other items. Available in both black and white, this elegant lamp is the perfect addition to any workspace.

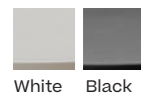

Color temperature: 2700K, 3 step.
CRI: >90
Lumen maintenance:
L70 48.000 hours
(0% of initial light output
maintained)

IP20



Screen

Wicker desk dividers, available in both frontal and lateral designs. Made from high-quality wicker material, these dividers are perfect for creating organized workspaces and reducing distractions. Available in both natural and dark colors, our wicker desk dividers add a touch of elegance to A desk while also providing practical benefits. Whether you need to create private workspaces, organize your desk, or simply add a touch of style, our wicker desk dividers are the perfect solution.

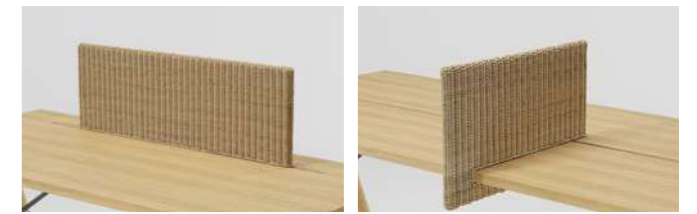

Frontal Screen 90x30 cm / 35,4x11,8" Side Screen 60x40 cm / 23,6x15,7"

repetir en negro



Power and USB connectivity

Moving sockets for the A desk system, available in both plug and USB A/C versions. These versatile sockets provide easy access to power and charging options while maintaining a sleek and organized workspace. Upgrade your desk with our functional and stylish lateral moving sockets today.

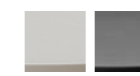

White Black



Plug



USB charger Type A & C (25 W)





Chair

KSA000100

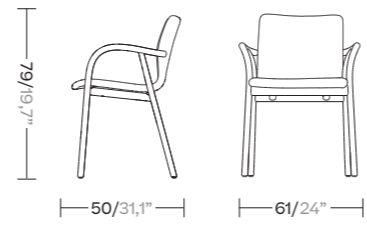

Home Deck

KSA000200

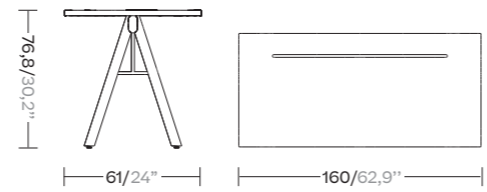

Meeting table

KSA000300

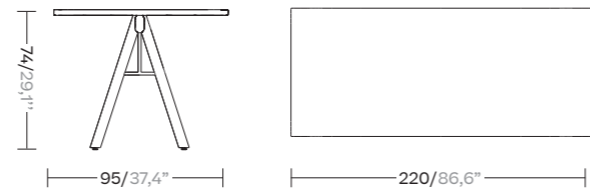



Kall, by Kettal Studio

Introducing the Kall Collection - a modern solution for private and comfortable conversations. We believe that a phonebooth should simply be the door of a meeting room, which is why we have made the glass door the protagonist, and the space of the "Phonebooth" corresponds to the projection of this door, making it appear embedded against the wall when viewed frontally. Our design ensures minimalism and functionality without any unnecessary frills.

Privacy is a key aspect, and we understand that users need a discreet environment for confidential meetings. Our small side walls provide structural support while also maintaining privacy for documents, device screens, and even facial expressions during a conversation. The addition of a translucent curtain further enhances the sense of protection against prying eyes.

We understand that a phonebooth should not be a cold space, so we have created a warm and inviting environment. Our design provides a pleasant atmosphere, making it closer to a meeting room or a home room rather than a typical elevator cabin.

Technology is an essential component, and we have ensured that the technology is intuitive and user-friendly. Everything is controlled electronically, with scene creation systems, table height regulation, ventilation control, and connectivity all intentionally hidden. Our interaction controls simulate the controls of old HIFI equipment, emphasizing that this booth is a simple and pleasant space where users can provide the main technology using their own devices. For tech-savvy users, we also offer a touchscreen control system.

The Kall Phonebooth family consists of various sizes. The "S" is the basic and standard size. The "M" is 30cm wider, allowing for a swivel armchair, similar to a lounge room, with a relaxed work posture. We also offer an "L" version for two people and a "XL" for 4. All of our phonebooths are modular, which means they can be combined to create special configurations according to the situation.







Kall S

KSB300100

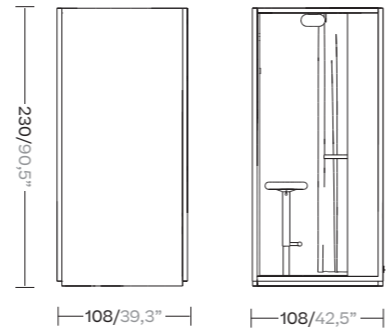

Kall M

KSB300200

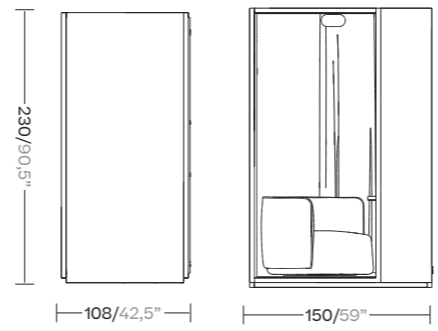

Analog controller

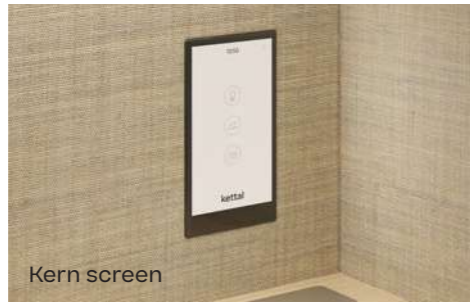

Kern screen

Side panels

Wood



Soft Beige
LW1



Soft Cream
LW2

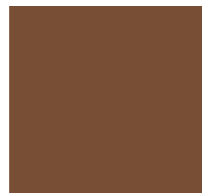

Light Brown
LW3



Light Oak
CW1

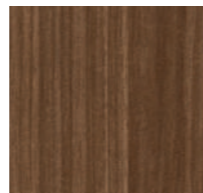

Dark Oak
CW2





Pavilion O, by Kettal Studio

The Pavilion O is a versatile and elegant structure that can be used in a variety of indoor settings, including offices, conference rooms, lobbies, and other commercial or public spaces. It can be used as a standalone structure or as part of a larger design scheme, and its modern aesthetic and high-quality materials make it a perfect fit for contemporary or minimalist interiors.

Designed to provide an elegant and functional space for a variety of purposes, the Pavilion O is a unique and eye-catching structure that combines the natural beauty of wood with the sleekness of curved glass and the durability of PET materials. Its side panels and shelf provide additional functionality and storage space,

while the optional sideboard adds even more versatility and customization options.

The lighting system is designed to complement the Pavilion O's modern aesthetic, with sleek and minimalistic fixtures that blend seamlessly into the structure's design. With dimmable LED lights, you can adjust the brightness to your liking and create a warm and inviting atmosphere for meetings, events, or other gatherings.

Whether used as a private workspace, a meeting area, or a stylish addition to an office or public space, the Pavilion O is a beautiful and practical structure that adds value and elegance to any indoor environment.







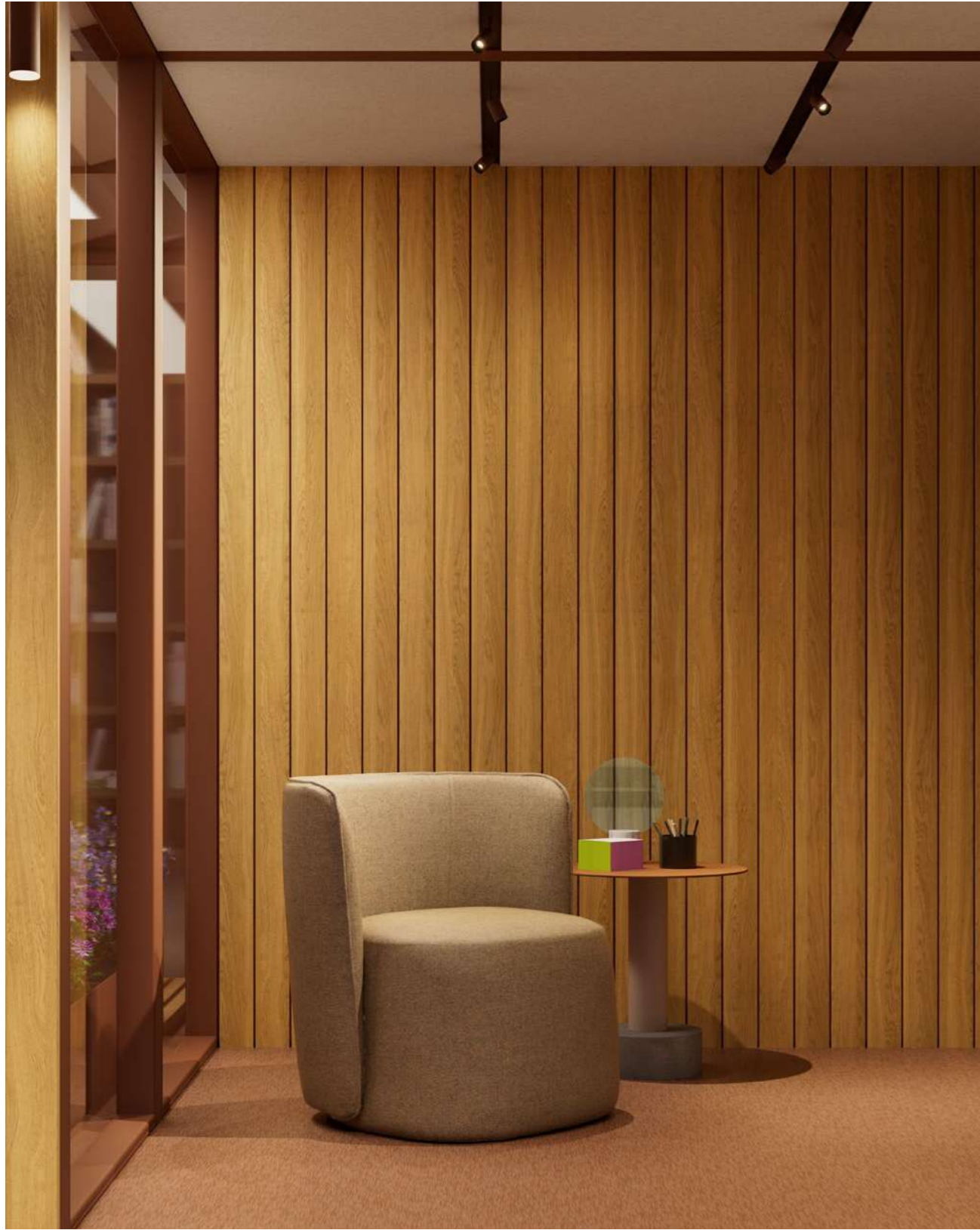



Ledge Shelf & hanger

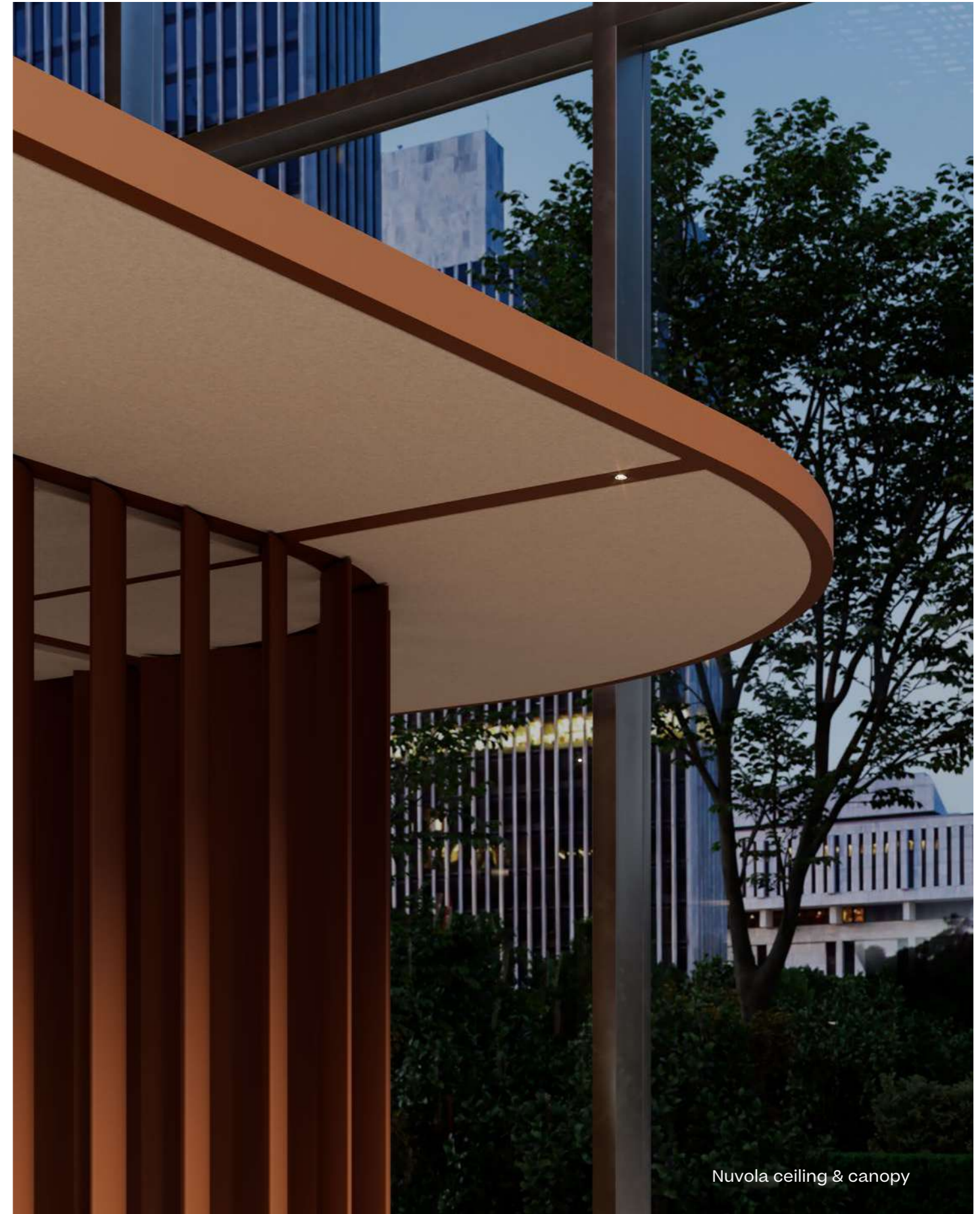

Nuvola ceiling & canopy



Lighting

Dots Pendant

Magnetic and adjustable hanging lamp (48v) or ceiling-recessed lamp (24V)



Dots Pendant Open/Close

Magnetic and adjustable hanging lamp (48v) or ceiling-recessed lamp (24V)



Dots Articulated

Magnetic and adjustable hanging lamp (48V).



Dots Light Down/Up

Column lamp with accessories and options.

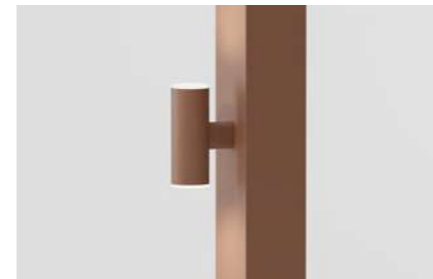

Dots Fastened

Ceiling-recessed lamp (24V)



Dots Multidots 6 /12

Magnetic and adjustable with 48V rail integration.



Led Track Curtain

This linear, homogeneous lighting is integrated with the low-voltage track for the side panels.



Led Track

Magnetic and adjustable with 48V rail integration.



Led Track Wall washer

Magnetic and adjustable with 48V rail integration.



Led Track slats integrated

Magnetic and adjustable with 48V rail integration.



Led Track integrated

This linear, homogeneous lighting is integrated.

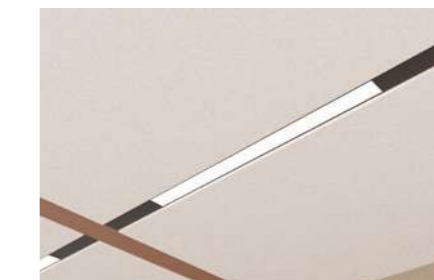

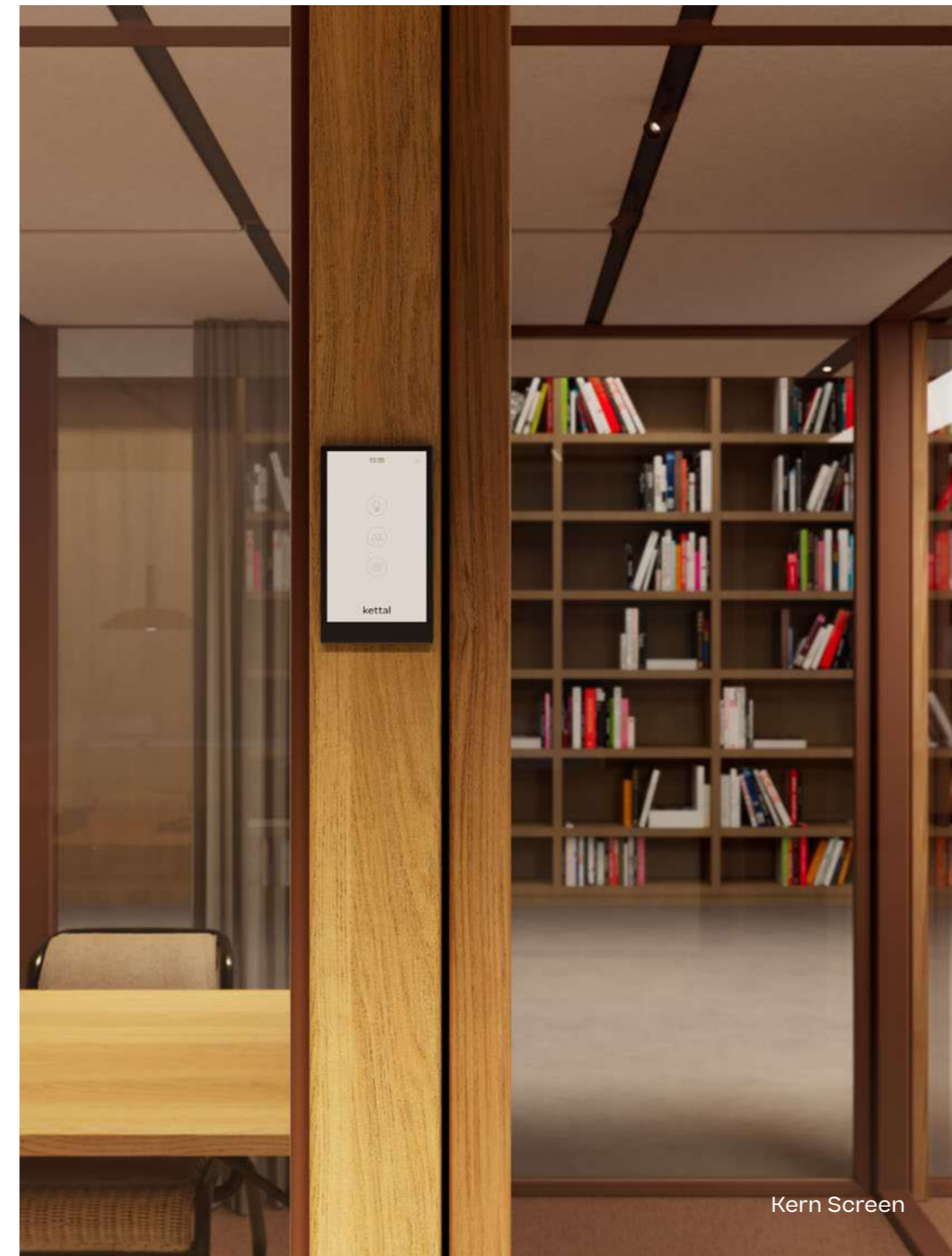

Kern Screen

Materials

Terrain Elements*

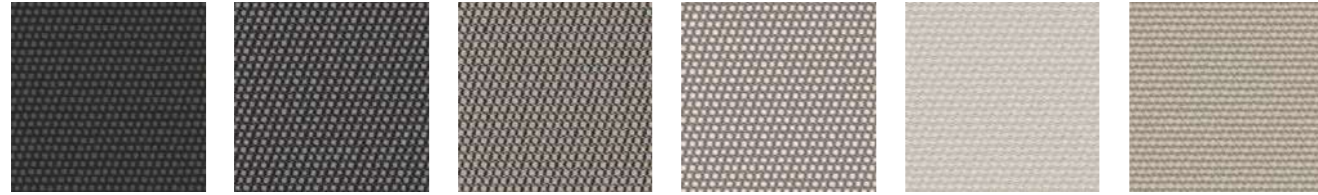

Charcoal 01L-01T Cumulus 02L-02T Fog 09L-09T Porous Grey 08L-08T Snowcap 03L-03T Moonstone 07L-07T

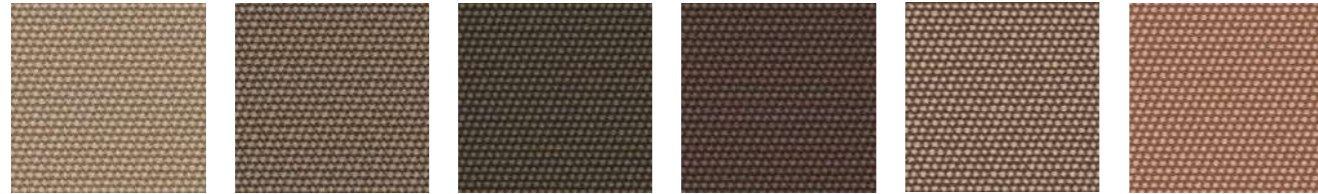

Karakum 06L-06T Cambium 12L-12T Raku 11L-11T Clove 13L-13T Desert Rose 14L-14T Pink Salt 15L-15T

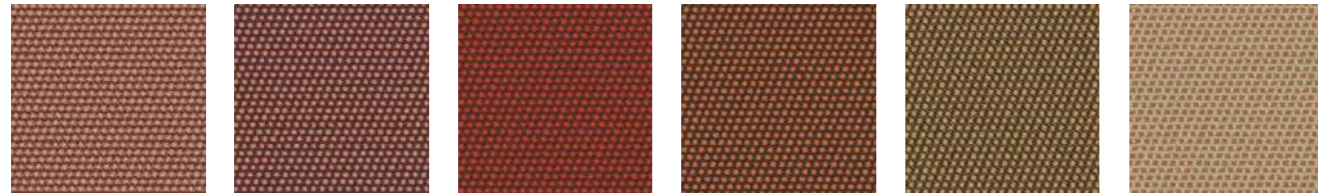

Pacific Dawn 16L-16T Acer 17L-17T Firetail 18L-18T Glowing Ember 19L-19T Tiger Eye 05L-05T Goldrush 04L-04T

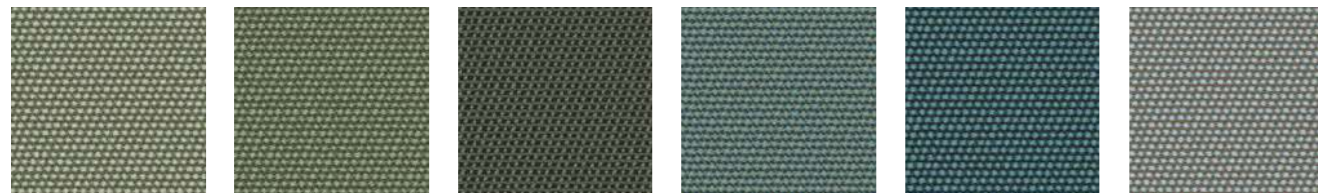

Sea Heart 22L-22T Heath 21L-21T Peppercorn 20L-20T Rock Pool 23L-23T Tropic 24L-24T Skylark 25L-25T

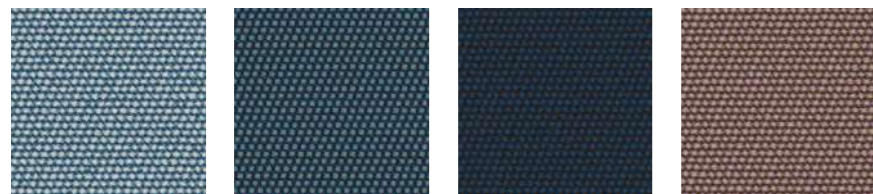

Nautica 26L-26T Blue Reef 27L-27T Cosmos 28L-28T Amethyst 29L-29T

Tonale Boucle Laminate

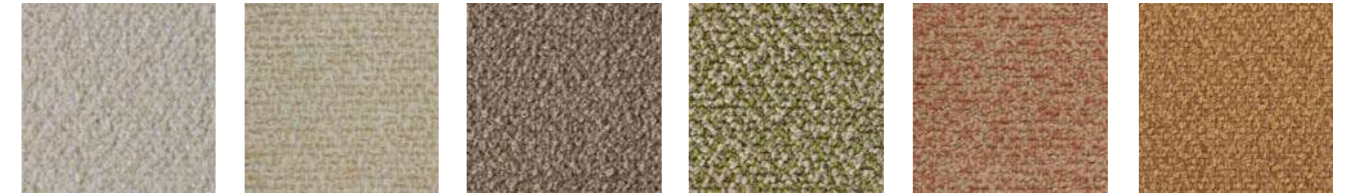

White Poppy 81L Sesame 82L Anise 83L Dill 84L Allspice Jamaica 85L Bird's foot 86L

Tonale Lino Laminate



White Chia 61L Fennel 62L Elwendia 63L Brown Mustard 64L Kampot 65L Fenugreek 66L

Maya curtains (outdoor)

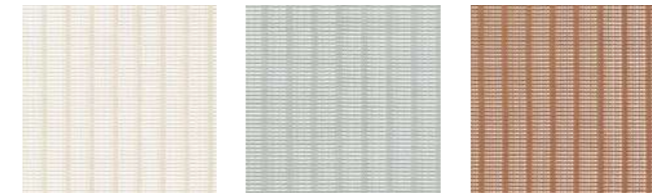

Bonneville J06 Nevada J03 Colorado J08

L: Laminate
T: No laminate (only for umbrellas)

Materials

Terrain Fabrics Laminate

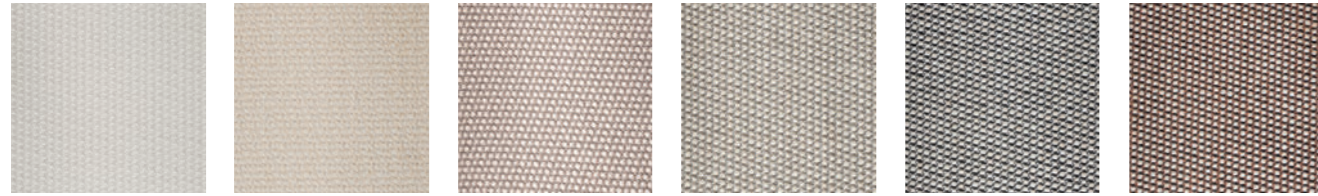

White Cliffs 290 Dry Sand 285 Porous Grey 291 Limestone 292 Fog 289 Deer 286

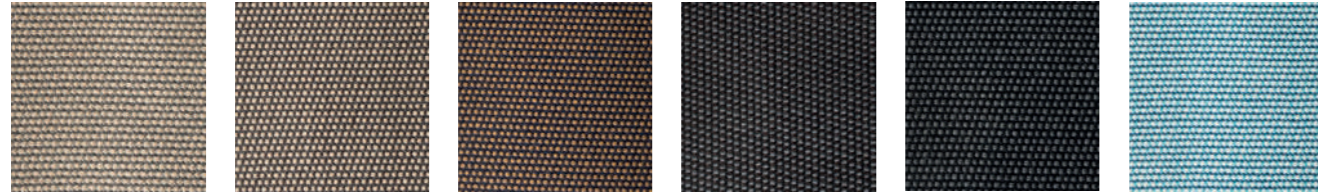

Wet Sand 287 Cobblestone 302 Cyprus Umber 301 Loam 297 Charcoal 293 Arctic 295

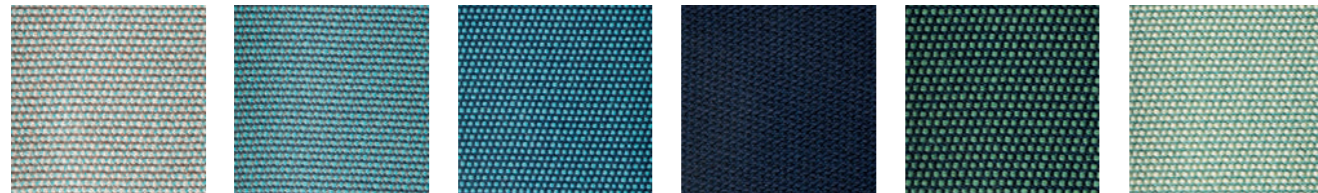

Fjord 248 Cerulean 314 Caribbean 298 Atlantic 311 Rainforest 312 Lagoon 249

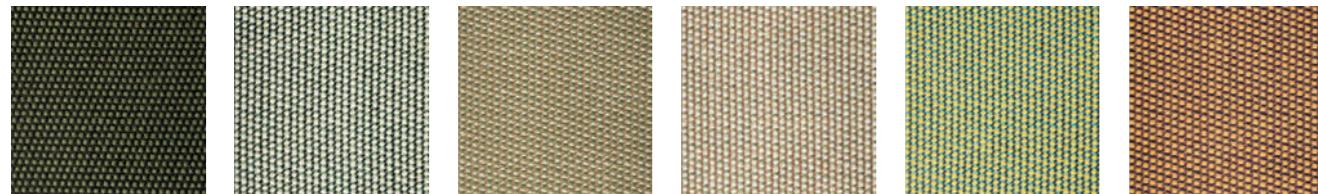

Cedar 288 Moss 296 Olive 313 Autumn 315 Summer Sky 317 Flamma 304

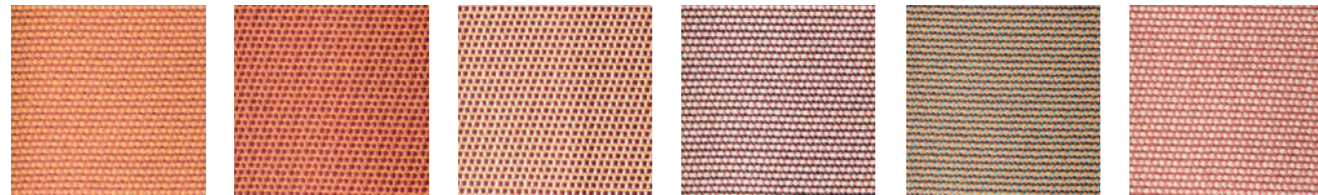

Sunrise 299 Saffron 305 Burnt Sienna 306 Ash Rose 294 Cooper 316 Dusk Pink 307

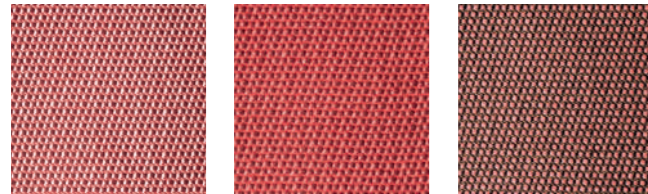

Flamingo 310 Coral 308 Sandstone 309

Parallels

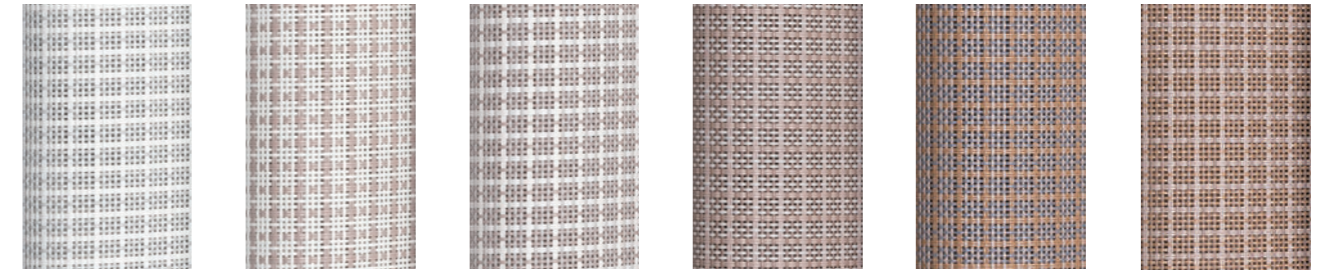

White Anemone 527 Lace Coral 528 Padina 564 Saline 571 Alaria 572 Sponge 536

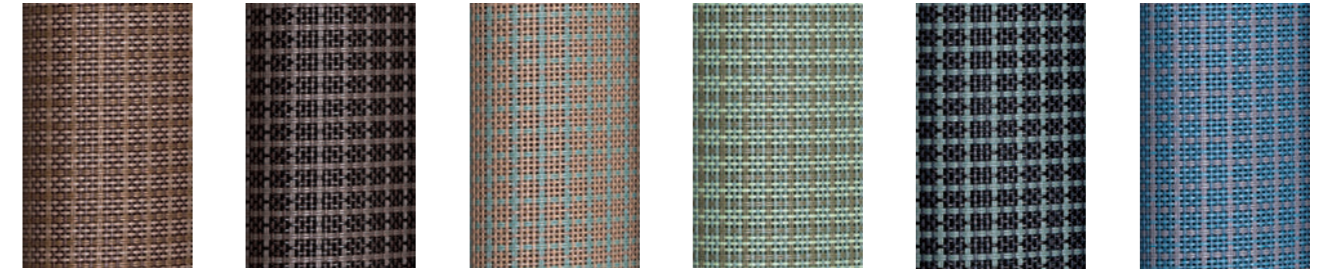

Fucus 537 Urchin 547 Kelp 556 Turtle Grass 553 Deep Ocean 570 Winter Sea 569

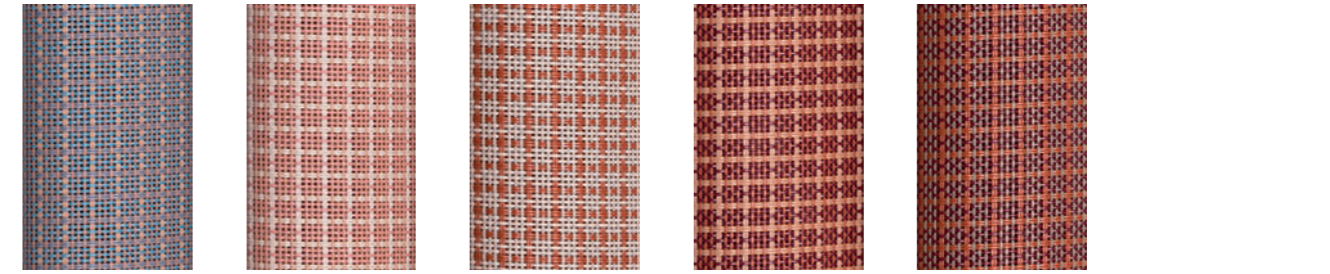

Xenia 568 Plumaria 567 Irish Moss 559 Coral 562 Dulse 565

Parallels (Porotex)



White Salt 989 Silver Moon 990 Sea Shell 991 Beach Sand 992 River Sand 988 Black Urchin 993

Materials

Roll Straps

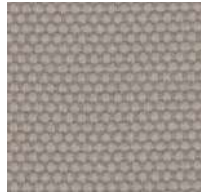

Cotton
CR1



Calatea
CR2



Plume Thistle
CR3

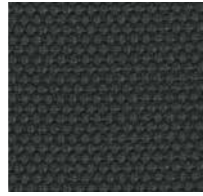

Burnt Wood
CR4



Sun Flower
CR5

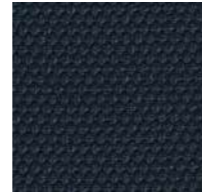

Sea Holy
CR6

Piping



Rosemary
MR1



Whole Clove
MR2



Mustard Grain
MR3



Sea Salt
MR4



Ground Pepper
MR5



Black Salt
MR6



Poppy Seed
MR7



Rose Harissa
MR8

Ceramics

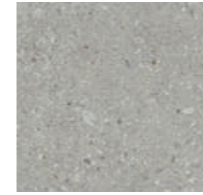

Ceppo di gre
(Pavilions)



Du Gent Grey
(Giro/Base Kitchen)

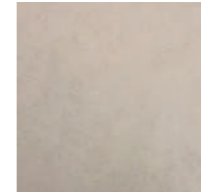

Neutral Caliza
(Giro/Base Kitchen)

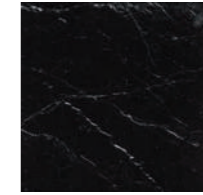

Royal Black
(Giro)

Marble

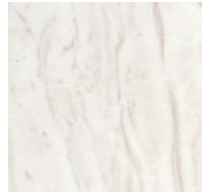

Glaze paints



Erinite
376

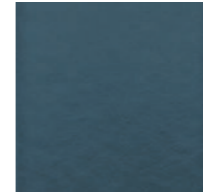

Montana
377



Indian Sapphire
371



Dolomite
373



Obsidian
372



Jasper
375



Black Diamond
374



Smoky Quartz
370

Minera



Antique Rose
M13



Atlas
M14

Wood

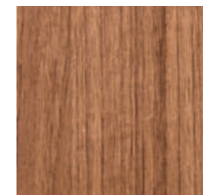

Teak

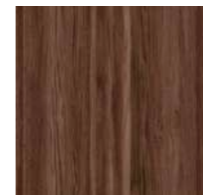

Cinnamon teak

Aluwood

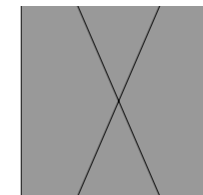

Atlantic White Cedar
930

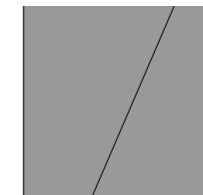

Western Red Cedar
920

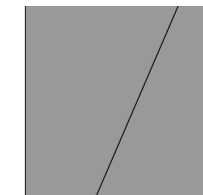

Smoked Wenge
910

Materials

Terrain Paint



Slate Stone 01C Misty Smoke 02C Ash 03C Bone 04C Tuff 05C Wet Stone 06C Sand Dune 07C Dry Clay 08C Arabica 09C Sepia 19C

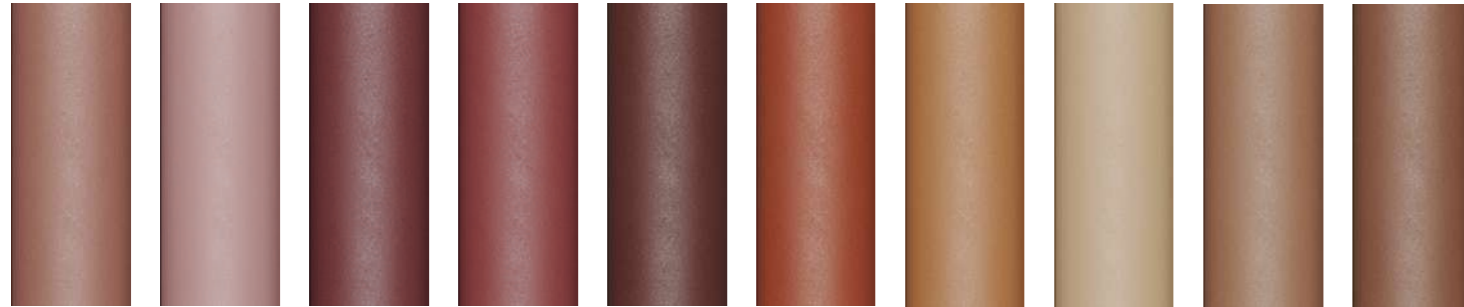

Rose Canyon 16C Blossom 20C Ruby Dust 18C Sunset Glow 17C Terrarosa 15C Terracota 14C Amber 13C Ginger Root 12C Desert Storm 11C African Savannah 10C

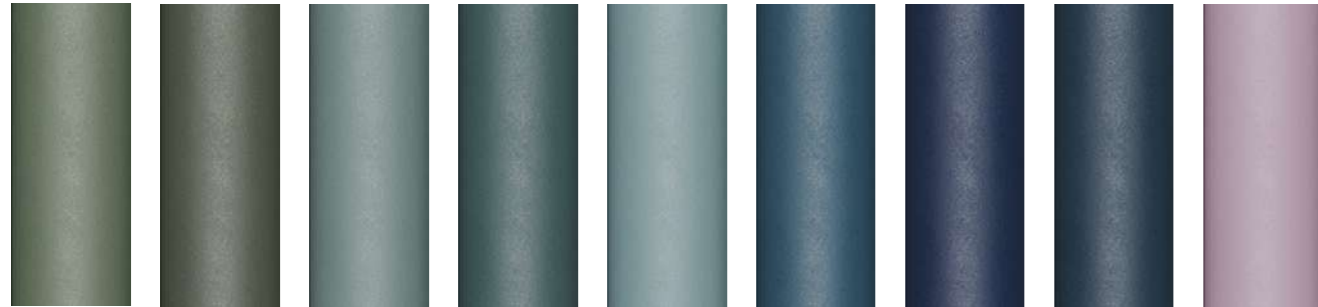

Spring Meadow 28C Kombu 29C Forest Stream 27C Sea Moss 26C Glacier Ice 25C Polar Sky 24C Nightfall 23C Indigo 22C Wild Lupin 21C



Galena 33C Bronze 30C Corten 31C Manganese 32C

Glass Paints (indoor only)



Tuff 05C Sand Dune 07C Rose Canyon 16C Dry Clay 08C African Savannah 10C Sea Moss 26C



Indigo 22C Ash 03C

Materials

Base (Eolias indoor & A only)



Rice Cake F01 Toasted Almond F02 Pecan Pie F04 Indian Sunset F05 Stardew F09 Orion Grey F10

Leather (Eolias indoor & A only)

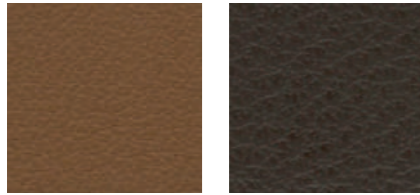

Tumbleweed 362 Kobicha 363

Relate Fabrics (only Pavilion O)



V07 V04 V02 V09 V10 V12

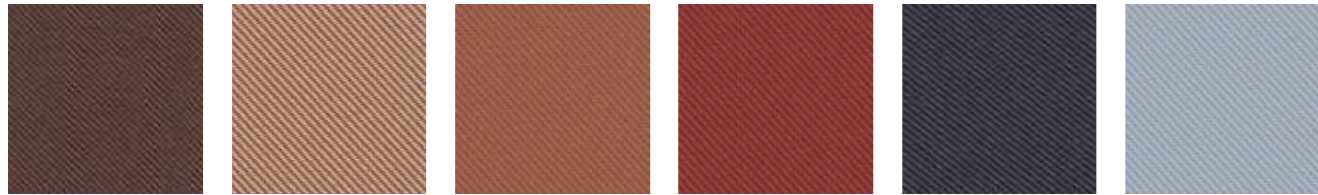

V13 V17 V18 V20 V06 V25



V31 V32 0401 0431 0441 0461

Indoor

Nuvola (Pavilion O)



Andina Grey PF1 Ibiza Sand PF2 Hickory Brown PF3 Baja Dunes PF4 Iron Ore PF5 Clary Sage PF6

Compact Wood (Kall collection)



Light Oak CW1 Dark Oak CW2 Soft Beige LW1 Soft Cream LW2 Light Brown LW3

Wood (A collection)

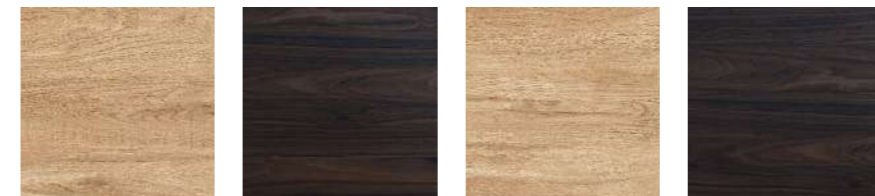

Natural Oak (table) Burnt Oak (table) Natural Ash (chair) Burnt Ash (chair)

We would love to hear from you.

Head office

Kettal Barcelona
Aragón, 316
08009 Barcelona, Spain
T. (34) 93 487 90 90
F. (34) 93 487 90 66



See all the finishes colors
of the images here

Showrooms

Miami Showroom
147 Miracle Mile
Coral Gables,
Florida 33134, USA
t. (1) 786 552 90 22
miami.store@kettal.es

Paris Showroom
80, Blvd Malesherbes
75008 Paris, France
t. (33) 1 43 59 51 40
boutique.paris@kettal.es

London Showroom
Contract & Workplace
15-16 Dufferin St,
London EC1Y 8UR, Reino Unido
t. +44 7507 717891

Marbella Showroom
Crtra. de Cádiz, Km.179
(entre el Marbella Club
y el Guadalpin)
29600 Marbella, Spain
t. (34) 95 277 89 89
tienda.marbella@kettal.es

Chicago
The Mart.
222 Merchandise Mart Plaza,
Suite 10-155
Chicago, IL 60654 USA.
T. 312.244.0527
chicago.showroom@kettal.es

New York
The D&D Annex:
222 East 59th Street
Suite 222-333
New York, NY 10022, USA
t. (1) 917-992-9419
newyork.showroom@kettal.com

Kettal Barcelona
Aragón, 316
08009 Barcelona, Spain
T. (34) 93 488 10 80
tienda.bcn@kettal.es

Melbourne Showroom
510 Church Street Melbourne
Richmond VIC 3121, Australia
t. (03) 9957 8799

Press Kit



To download the Press Releases and
high res images please register in the
Press Area here